

POOL / SPA PROFILE GUIDE

Use this guide to aid you in taking site measurements. Accurate site measurements are required in order to verify that the lift you want is going to work for your application. Please be as accurate and thorough as possible. If you do not see a profile that closely matches your pool profile, please draw your own profile and complete the appropriate measurements. Fax or email completed Profile Guides back to Aqua Creek Products.

FAX: (406) 549-2602

EMAIL: Your sales rep (Subject: Pool Spa Profile Guide)

① Roll Out Profile

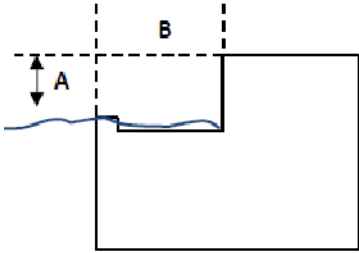

② Partially Recessed Profile

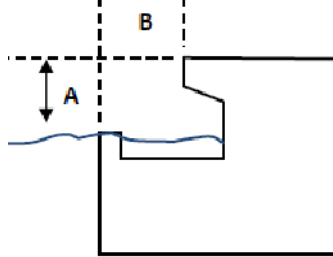

③ Fully Recessed Profile

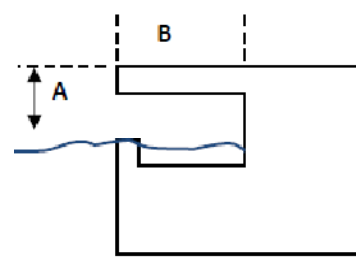

④ Fully Recessed w/Parapet

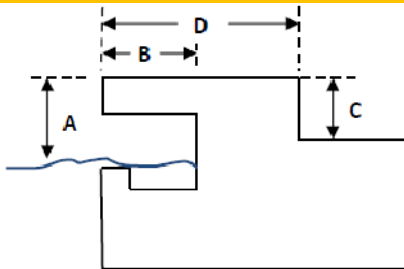

⑤ Flush with Deck Profile

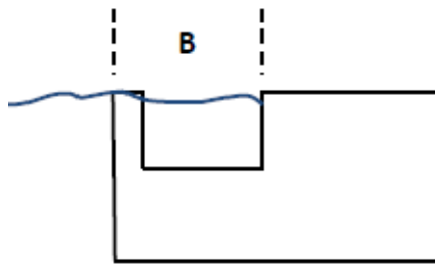

⑥ Squared Edge Profile

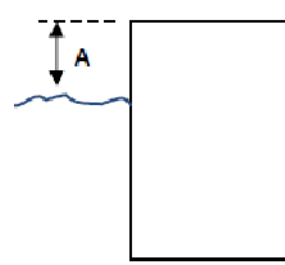

⑦ Raised Pool/Spa Profile

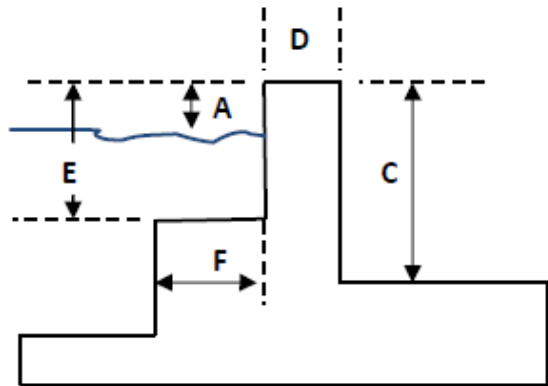

PROFILE # _____

POOL TYPE:

Commercial Residential

DECK MATERIAL:

Concrete Wood Other

MEASUREMENTS:

A = Deck to Water _____ Inches

B = Gutter width _____ Inches

If Applicable:

C = Height of Parapet (Curb/Wall) _____ Inches

D = Width of Parapet (Curb/Wall) _____ Inches

E = Spa Seat Depth (Top of wall to seat) _____ Inches

F = Spa Seat Width _____ Inches

Floor to ceiling measurement _____ Inches



QUESTIONS? Call Aqua Creek @ (888) 687-3552 or (406) 549-0769